

moodlemoot™

FINLAND 2024

Attendee Guide

27.-28.5.2024, Helsinki



Welcome

Welcome to University of Helsinki!

I warmly welcome you to the University of Helsinki. While we are proud of our almost 400 years heritage, we aim to be at the forefront of educational technology developments. During my career, I have seen and participated in this development firsthand. In the 1990's lecture materials started to be shared on web pages, back then a new revolutionary technology. While this was already a marked improvement compared to the endless copying of lecture notes that was standard in the 1980's, it did not allow for organized interaction with the students. Moodle raised the online teaching environments to a new level, and was rapidly and widely taken into use at our university in the 2000's. While Moodle was never strictly enforced to be used at every course, thanks to good features and guidance it become so widely used that students expect a Moodle page to exist for every course – if a course does not have one, students complain the course does not exist!

Now the teaching technologies are developing to new levels – videos and videoconferencing have been common since the 2010's, and now in the 2020's virtual reality and generative artificial intelligence have been introduced to the mix. Our university is now embracing also these new technologies – and not only separately, but also in concurrent combination. I am happy to see in your programme that you are exploring how the Moodle environment can be enhanced with these newest developments.

I wish you a very fruitful meeting and that you also get to enjoy the magical feeling of the Nordic white nights!

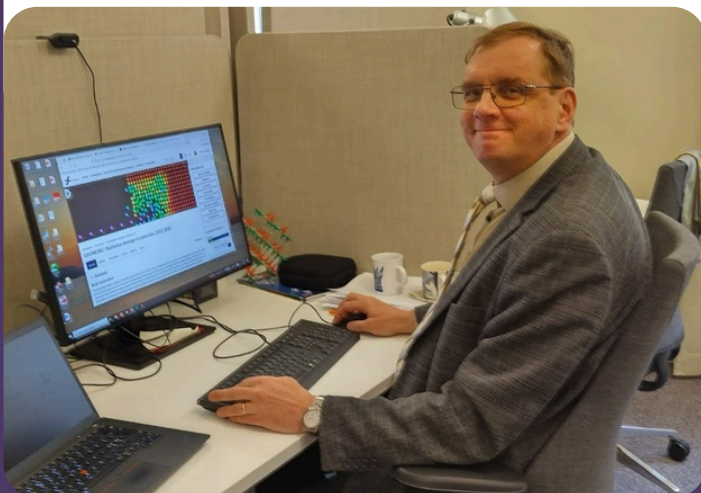

Kai Nordlund
Vice rector, education and digitalization

Venue

The venue is University of Helsinki's historical and recently renovated main building in the downtown Helsinki.

Address: Fabianinkatu 33, Helsinki

The venue is located 10 minute walk from the central railway station for train, metro, tram, and buses. The University of Helsinki metro station is 200 metres from the venue and there are tram stops located right next to the building.

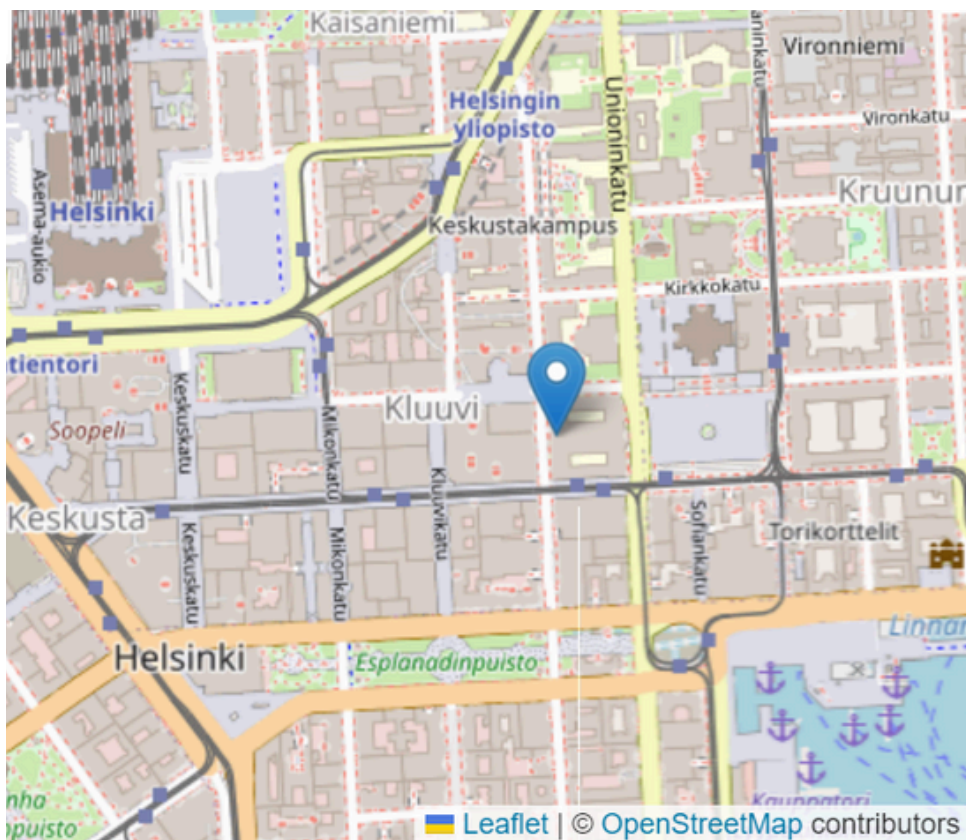

Practical information

Info and registration desk: located on the ground floor of the main building. Info and registration open: Mon 8:30-17, Tue 9-16:30

From the info and registration desk you can collect your MoodleMoot pass as well as complementary drink tickets for the MoodleMoot party.

During the event in case of needing assistance you can contact the info desk or people wearing orange lanyards and pink Ask Me! -pins.

For safety reasons, the conference pass must be worn at all time during the event.

Luggage and coatroom: Coats and other personal belongings can be stored in lockers on the ground floor of the venue. There is no separate cloakroom for conference attendees. Ask the staff for assistance if needed. Remember to empty the locker upon leaving the venue. The university of Helsinki or MoodleMoot Finland is not responsible for lost items.

Larger luggage cannot be stored at the venue. The central railway station has luggage lockers that can store bigger luggage.

Food and beverages: Lunch, morning and afternoon coffee and evening party included for all participants. Vegan option is always available.

Certificates and feedback: After the MoodleMoot certificates and a feedback survey will be sent to the participants.

WiFi: There are two free wireless networks available, Eduroam and HelsinkiUni Guest visitor networks.

If you have an eduroam user account at your home university you can use the same account in the eduroam network at the University of Helsinki.

Password for Helsinki Uni Guest visitor network: uniguest

Communication during the conference: The official chat room of the conference is at the Moodle Community Matrix space (invite link: <https://matrix.to/#/#suomeksi:moodle.com>). Matrix can be used from the browser or with an app. If you haven't used Matrix before, we recommend the Element application for accessing the chat.

Photos and video: Photographers and videographers will be circulating at the event. Some of the presentations will be recorded and later shared on MoodleMoot channels. If you don't want appear on photos or video, MoodleMoot website or social media, please contact the Info or moodlemoot@helsinki.fi.

Community photo: Please join us when we take a photo together on Monday before lunch. Let's show the whole Moodle community how many we are!

Place and time: Agora on the first floor at 11:30-11:45 on Monday 27th of May.

Remember to use the hashtag #MootFI24 to join the conversation on social media!

Agenda - Day 1

08:30-09:15 Registration and coffee

09:15-10:20 Welcome and Keynote: Marie Achour

10:30-11:30 Session 1

11:30-11:45 Community photo

11:45-12:40 Lunch

12:40-13:40 Session 2

13:50-14:30 Session 3

14:30-15:00 Afternoon coffee

15:00- 15:50 Session 4

16:00-16:50 Keynote: Benjamin Cowley

19:00 MoodleMoot Party

Agenda - Day 2

09:00-09:30 Coffee

9:30-10:20 Keynote: Tim Hunt

10:30-11:30 Session 5

11:30-12:30 Lunch

12:30-13:30 Session 6

13:30-14:00 Afternoon coffee

14:00-15:00 Session 7

15:10-16:00 Panel discussion and closing words

16:00-16:30 Refreshments

For the full programme see
moodlemoot.helsinki.fi/programme

Maps

1st floor

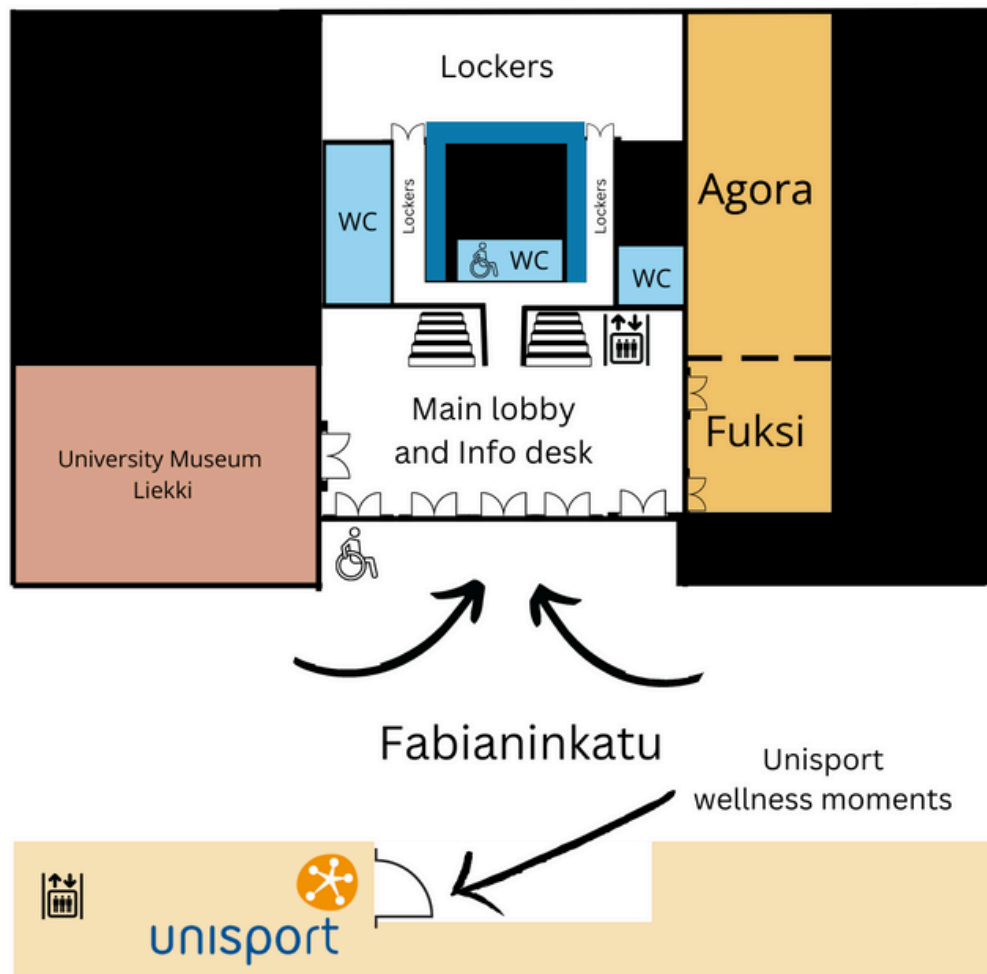

1st floor

- Info desk
- Lunch (Agora and Fuksi)
- Lockers
- Community photo (Agora)
- University museum Liekki
- Access to Unisport across the street

3rd floor

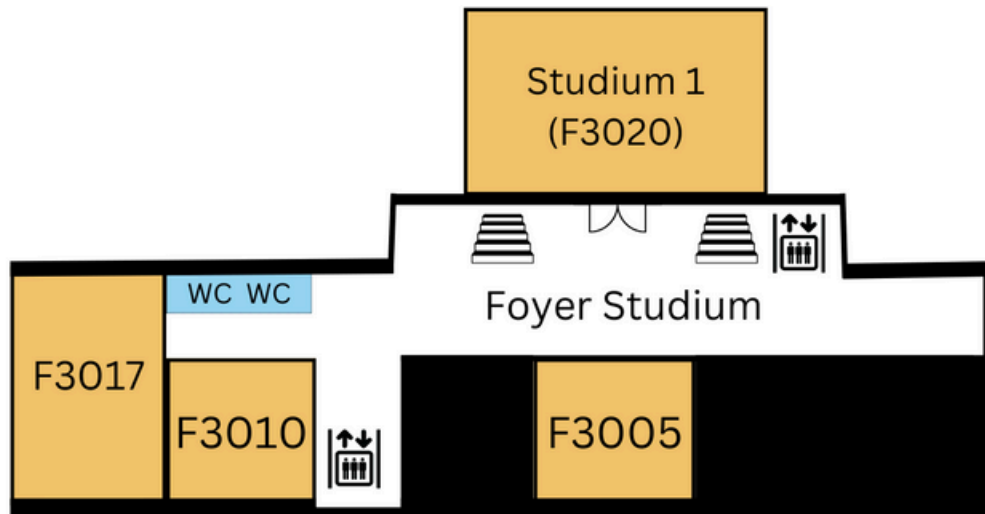

4th floor

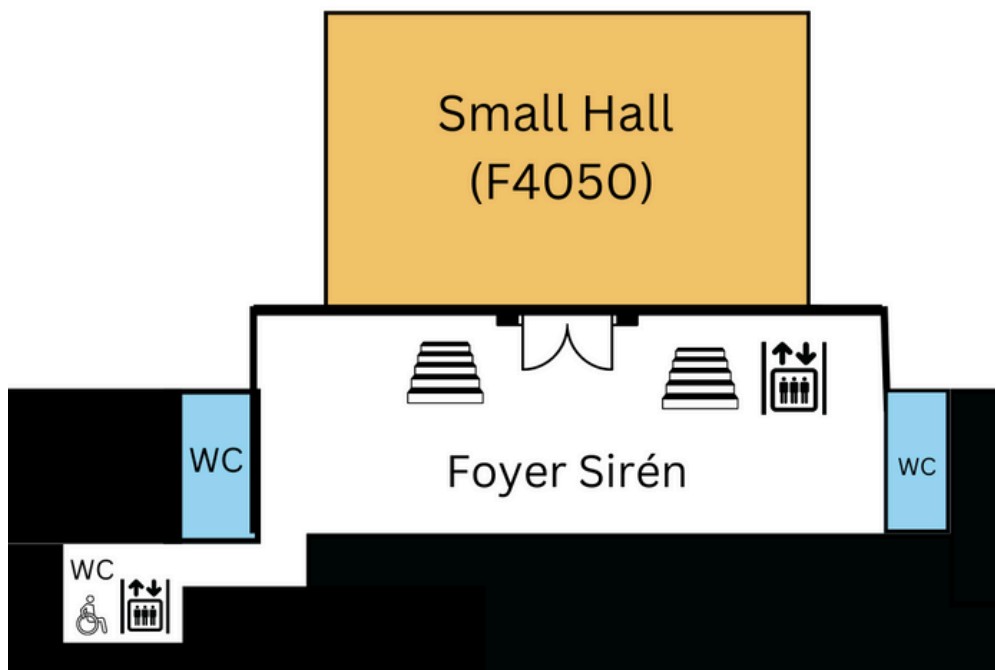

3rd and 4th floor

- Sessions: Small Hall (F4050), F3005, F3010, F3017, Studium 1 (F3020)
- Coffee: Foyer Studium and Foyer Sirén
- Sponsor stands: Foyer Studium
- Refreshments: Foyer Studium

MoodleMoot Party

When: Monday 27.5. at 7pm

Where: Butchers cocktail bar

Address: Uudenmaankatu 16-20, Helsinki

Be sure to keep your calendar clear for Monday evening as all attendees are invited to join the MoodleMoot party! The venue, Butchers, is a cocktail bar located ca. 1km from the conference venue. Remember to take your conference pass with you as it serves as an entrance ticket to the party!

Vegetarian cocktail food and welcome drinks are served at the beginning of the night. Later in the evening we'll get to enjoy some live music by Café de Abejas, the dandiest cabaret quartet in Finland, and the house DJ will make sure to entertain you well into the night!

You will receive your complimentary drink vouchers along with your conference pass. Be sure to taste our official MoodleMoot cocktail!



Sponsors



Wellness

To power the brain and body, we do not only offer great sessions and good food, but also moments for relaxation and culture.

Over the course of the conference, we offer a short and complementary “exercise breaks” to help the body and mind relax between sessions.

In addition, we offer complementary yoga/relaxing sessions at Unisport, located right across the street. The sessions are designed so that you can just walk in, no need for any sports gear. Please note that the space is limited (18).

Yoga/relaxation sessions:

Monday at 12:15-12:35

Tuesday at 11:40-12:00

All sessions are in English

Place: Fabianinkatu 20,
Unisport, floor K3

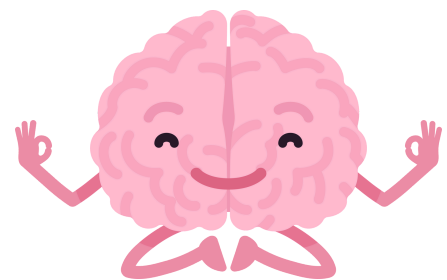

University Museum Liekki is open

on Tuesday 28th of May from 12:00 to 16:00.

See the new *Food for all* -exhibition and

learn about the history of the University of Helsinki!

Free admission with the Finnish Museum Card.

Accessibility

We strive to make MoodleMoot as accessible as possible. Please let us know if we can assist you in some way. Sometimes step-free access, accessible service or just the right piece of information may require some collaboration. During the event, the student helpers, porters and local organising committee can provide assistance. Before the event, please ask the local organising committee at moodlemoot@helsinki.fi

In brief, step-free access should be available to all the rooms and services within the conference venue. Some rooms, like the Small hall have a platform stair lift. Moreover, there are two elevators large enough for powerchairs and similar larger mobility aids (width 95 cm and length 130 cm or 38" and 52"). One elevator is right next to the lobby on Fabianinkatu side and provides access to the rooms starting with the letter "F". Please enter the conference venue using the entrance on Fabianinkatu. It is step-free and right next to most services.

Organisers

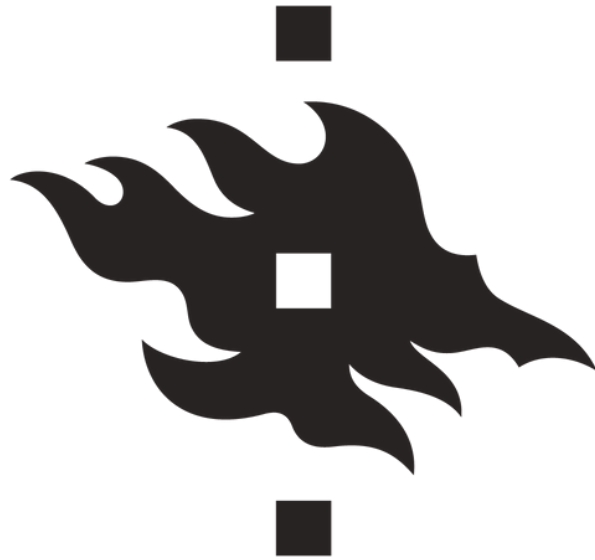

UNIVERSITY OF HELSINKI

Services for Digital Education and Continuous Learning, Teaching and Learning Services

Centre for Information Technology

moodlemoot™

FINLAND 2024

Welcome to Helsinki!



Web: moodlemoot.helsinki.fi
Contact: moodlemoot@helsinki.fi